

ORDERING GUIDE: BDA/BDG ENGINE SYSTEMS (CONVENTIONAL)

IGNITION LEAD ORDER DETAIL

Please complete in **BLOCK CAPITALS**

Dealer: _____

Your Name: _____

Address: _____

Post Code: _____

Telephone: _____ Mobile: _____

Fax: _____

LEAD TYPE REQUIRED (please tick ✓)

Copper Core (Black / Unprinted) 7mm

Electroports 70 (Black) 7mm

Electroports 80 (Blue) 8mm

Competition KV85 (Red) 8.5mm

If unsure, please refer to: www.magnecor.co.uk and click 'Product Information'

Or call our Technical department.

YOUR VEHICLE DETAILS

Vehicle Make/Model: _____ Year: _____

Engine Type: E.g. Honda Civic 1.6 _____

Engine Code: E.g. B16A2 _____

DISTRIBUTOR CAP TYPE

Make: _____ Model: _____

BOOT TYPE AT DISTRIBUTOR CAP: Straight 90° (right angle)

FITTING TYPE (please see reference images below and tick or circle your type)

Conventional/DIN

Pin/M4

SAE/Post/Male

Other-Please Sketch

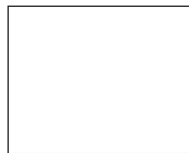
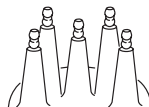

MEASURING YOUR LEADS CORRECTLY

PLEASE READ CAREFULLY TO ENSURE MEASUREMENTS ARE CORRECT.

When measuring existing ignition leads, measure from the spark plug metal terminal end to the distributor or coil metal terminal end (see diagram 1). For leads with deep boots (e.g. 16 valve engines) measure from the centre (see diagram 2). It is best to remove ignition leads from the spark plugs before measuring if the leads are difficult to reach.

Use a dressmaker's tape or alternatively lay a flexible tube/covered wire against the existing ignition lead. These can then be easily measured after the length has been established. This is the most accurate way to arrive at the correct lead lengths.

If no ignition leads are fitted to the engine, establish length by using tubing pipe or covered wire/flex or old ignition leads to make a temporary connection from the distributor to the spark plugs. Using this method will also help ascertain the best possible lead position along the entire length of the proposed ignition lead routing.

When measuring the R-100 10mm leads in particular, remember to take into account that the physical bulk of the 10mm ignition lead might necessitate longer lead lengths in order to go around corners and accessories. Also, fitting R-100 10mm ignition leads into original equipment tubes and brackets may not be possible. However, due to its exceptional flexibility the lead will squeeze into many aftermarket 8mm or larger lead separators.

CAPACITY: _____ NUMBER OF CYLINDERS: _____

SOHC/DOHC: _____ NUMBER OF VALVES: _____

TURBO S/CHARGED: CARB INJECTION:

COIL

Make: _____ Model: _____

Coil Lead Length: _____ (cm / inches)

COIL LEAD BOOT TYPES

Coil End: Straight 90° (right angle)

Distributor End: Straight 90° (right angle)

FITTING TYPE (please see reference images below and tick or circle your type)

Conventional/DIN

Pin/M4

SAE/Post/Male

Other-Please Sketch

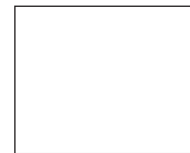
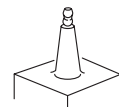
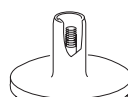
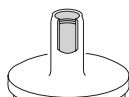
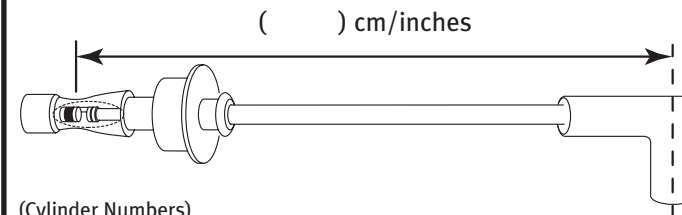

Diagram 1.



(Cylinder Numbers)

1) _____ 2) _____ 3) _____ 4) _____

OTHER RELEVANT INFORMATION: E.g. Specific Conversion Type

Diagram 2.

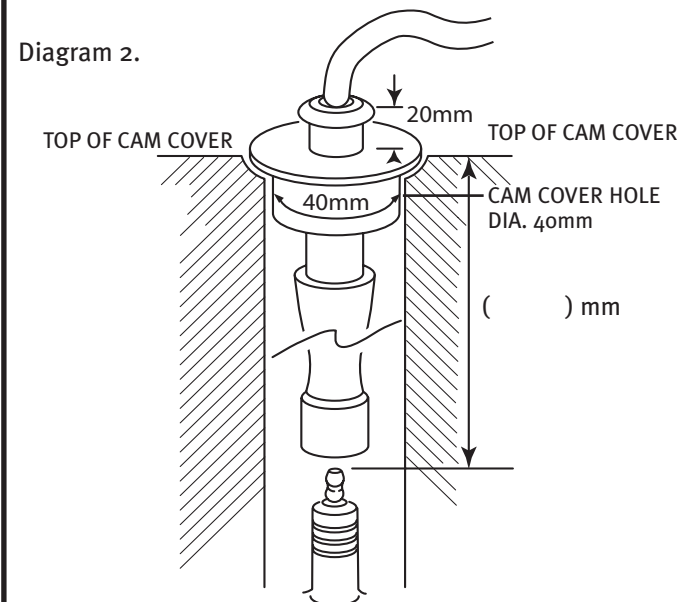

PLUG SIZE: (Please Tick)

20.8mm hex 16.0mm hex