



TECNO 2 SRL

LISTINO AGGIORNATO 2022

PREZZI SOGGETTI A CAMBI

**LISTINO PREZZI MANICOTTI SILICONICI
ADVANCED INNOVATION TECHNOLOGY ECHO**

[Le schede tecniche relative al materiale silicónico sono scaricabili nell' area Download](#)

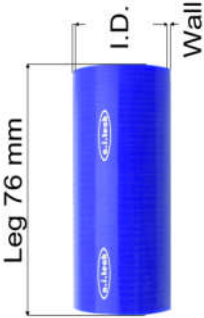
Manicotto accoppiamento / Silicone Straight hose						
Disegno / Drawing	Codice / Part Numebr	I.D. Diametro interno (mm)	Lunghezza / Leg (mm)	Strati / Ply	Spessore parete / Wall(mm)	Listino € iva esclusa /Price List
	ASCH19-ECHO	25	76	3	4,5	€ 5,70
	ASCH22-ECHO	25	76	3	4,5	€ 5,18
	ASCH25-ECHO	25	76	3	4,5	€ 3,51
	ASCH32-ECHO	32	76	3	4,5	€ 4,11
	ASCH34-ECHO	34	76	3	4,5	€ 4,37
	ASCH38-ECHO	38	76	3	4,5	€ 4,56
	ASCH40-ECHO	40	76	3	4,5	€ 4,88
	ASCH45-ECHO	45	76	3	4,5	€ 5,28
	ASCH48-ECHO	48	76	3	4,5	€ 5,63
	ASCH51-ECHO	51	76	4	5	€ 5,93
	ASCH55-ECHO	55	76	4	5	€ 6,09
	ASCH57-ECHO	57	76	4	5	€ 6,29
	ASCH60-ECHO	60	76	4	5	€ 6,49
	ASCH63-ECHO	63	76	4	5	€ 6,67
	ASCH65-ECHO	65	76	4	5	€ 6,72
	ASCH68-ECHO	68	76	4	5	€ 7,30
	ASCH70-ECHO	70	76	4	5	€ 7,39
	ASCH76-ECHO	76	76	4	5	€ 7,76
	ASCH80-ECHO	80	76	4	5	€ 7,99
	ASCH83-ECHO	83	76	4	5	€ 8,18
ASCH89-ECHO	89	76	4	5	€ 9,64	
ASCH95-ECHO	95	76	4	5	€ 10,87	
ASCH102-ECHO	102	100	4	5	€ 12,56	
ASCH114-ECHO	114	100	4	5	€ 13,33	
ASCH127-ECHO	127	100	4	5	€ 26,73	

Tubo dritto 1 metro silicone / 1 Meter Silicon Straight hose						
Disegno / Drawing	Codice / Part Numebr	I.D. Diametro interno (mm)	Lunghezza / Leg (mm)	Strati / Ply	Spessore parete / Wall(mm)	Listino € iva esclusa /Price List
	AHL6,5-ECHO	6,5	1000	3	4,5	€ 20,91
	AHL8-ECHO	8	1000	3	4,5	€ 21,96
	AHL9,5-ECHO	9,5	1000	3	4,5	€ 22,73
	AHL10-ECHO	10	1000	3	4,5	€ 23,13
	AHL12-ECHO	12	1000	3	4,5	€ 23,13
	AHL13-ECHO	13	1000	3	4,5	€ 23,41
	AHL16-ECHO	16	1000	3	4,5	€ 23,66
	AHL19-ECHO	19	1000	3	4,5	€ 25,37
	AHL22-ECHO	22	1000	3	4,5	€ 27,09
	AHL25-ECHO	25	1000	3	4,5	€ 28,79
	AHL28-ECHO	28	1000	3	4,5	€ 30,52
	AHL30-ECHO	30	1000	3	4,5	€ 31,65
	AHL32-ECHO	32	1000	3	4,5	€ 32,79
	AHL35-ECHO	35	1000	3	4,5	€ 34,52
	AHL38-ECHO	38	1000	3	4,5	€ 36,22
	AHL40-ECHO	40	1000	3	4,5	€ 37,94
	AHL45-ECHO	45	1000	3	4,5	€ 40,22
	AHL48-ECHO	48	1000	3	4,5	€ 43,64
	AHL51-ECHO	51	1000	4	5	€ 45,89
	AHL55-ECHO	55	1000	4	5	€ 49,51
AHL57-ECHO	57	1000	4	5	€ 53,13	
AHL60-ECHO	60	1000	4	5	€ 56,75	

AHL64-ECHO	64	1000	4	5	€	61,58
AHL68-ECHO	68	1000	4	5	€	65,21
AHL70-ECHO	70	1000	4	5	€	66,41
AHL76-ECHO	76	1000	4	5	€	76,07
AHL80-ECHO	80	1000	4	5	€	78,49
AHL89-ECHO	89	1000	4	5	€	84,19
AHL95-ECHO	95	1000	4	5	€	96,19
AHL102-ECHO	102	1000	4	5	€	111,09

Riduzione dritta silicone / Silicone straight reducer

Disegno / Drawing	Codice / Part Numebr	I.D. Diametro interno (mm)	Lunghezza / Leg (mm)	Strati / Ply	Spessore parete / Wall(mm)	Listino € iva esclusa /Price List
	SR19-13-ECHO	19-13	100	3	4,5	€ 12,65
	SR19-16-ECHO	22-19	100	3	4,5	€ 14,04
	SR22-19-ECHO	22-19	100	3	4,5	€ 13,44
	SR25-19-ECHO	25-19	100	3	4,5	€ 15,01
	SR32-25-ECHO	32-25	100	3	4,5	€ 11,44
	SR35-28-ECHO	35-28	100	3	4,5	€ 11,56
	SR35-32-ECHO	35-32	100	3	4,5	€ 12,08
	SR38-45-ECHO	38-45	100	3	4,5	€ 12,36
	SR35-38-ECHO	35-38	100	3	4,5	€ 11,83
	SR35-45-ECHO	35-45	100	3	4,5	€ 12,36
	SR38-51-ECHO	38-51	100	4	5	€ 12,82
	SR45-51-ECHO	45-51	100	4	5	€ 12,82
	SR45-60-ECHO	45-60	100	4	5	€ 13,67
	SR45-63-ECHO	45-63	100	4	5	€ 13,07
	SR51-57-ECHO	51-57	100	4	5	€ 13,27
	SR51-60-ECHO	51-60	100	4	5	€ 13,50
	SR51-64-ECHO	51-64	100	4	5	€ 13,72

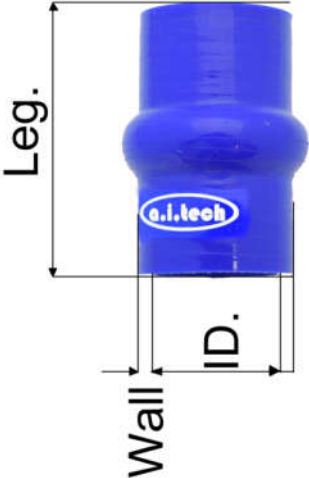

SR51-70-ECHO	51-70	100	4	5	€	14,26
SR45-76-ECHO	45-76	100	4	5	€	15,69
SR51-76-ECHO	51-76	100	4	5	€	16,89
SR51-83-ECHO	51-83	100	4	5	€	17,51
SR57-60-ECHO	57-60	100	4	5	€	13,27
SR57-64-ECHO	57-64	100	4	5	€	13,72
SR57-70-ECHO	57-70	100	4	5	€	14,26
Riduzione dritta silicone / Silicone straight reducer						
Codice / Part Numebr	I.D. Diametro interno (mm)	Lunghezza / Leg (mm)	Strati / Ply	Spessore parete / Wall(mm)	Listino € iva esclusa /Price List	
SR57-76-ECHO	57-76	100	4	5	€	16,89
SR60-70-ECHO	60-70	100	4	5	€	14,26
SR60-76-ECHO	60-76	100	4	5	€	16,89
SR60-80-ECHO	60-80	100	4	5	€	17,29
SR63-85-ECHO	63-85	100	4	5	€	17,80
SR64-70-ECHO	64-70	100	4	5	€	14,26
SR64-76-ECHO	64-76	100	4	5	€	16,89
SR64-80-ECHO	64-80	100	4	5	€	17,03
SR63-83-ECHO	63-83	100	4	5	€	17,15
SR63-90-ECHO	63-90	100	4	5	€	17,81
SR70-76-ECHO	70-76	100	4	5	€	16,89
SR70-80-ECHO	70-80	100	4	5	€	17,29
SR70-83-ECHO	70-83	100	4	5	€	17,59
SR76-80-ECHO	76-80	100	4	5	€	17,29
SR76-83-ECHO	76-83	100	4	5	€	17,51
SR63-89-ECHO	63-89	100	4	5	€	17,99
SR76-89-ECHO	76-89	100	4	5	€	18,20
SR80-90-ECHO	80-90	100	4	5	€	18,20
SR83-89-ECHO	83-89	100	4	5	€	18,47
SR83-102-ECHO	83-102	100	4	5	€	19,32
SR89-102-ECHO	89-102	100	4	5	€	19,53
SR102-114-ECHO	102-114	100	4	5	€	33,81
SR63-102-ECHO	63-102	100	4	5	€	18,72
SR76-102-ECHO	76-102	100	4	5	€	19,53

Manicotto flessibile / Silicon Hump hose						
Disegno / Drawing	Codice / Part Numebr	I.D. Diametro interno (mm)	Lunghezza / Leg (mm)	Strati / Ply	Spessore parete / Wall(mm)	Listino € iva esclusa /Price List
	SHH25-ECHO	25	102	3	4,5	€ 9,66
	SHH32-ECHO	32	102	3	4,5	€ 9,90
	SHH38-ECHO	38	102	3	4,5	€ 10,38
	SHH40-ECHO	40	102	3	4,5	€ 10,75
	SHH45-ECHO	45	102	3	4,5	€ 12,20
	SHH51-ECHO	51	102	4	5	€ 15,14
	SHH55-ECHO	55	102	4	5	€ 16,30
	SHH57-ECHO	57	102	4	5	€ 16,78
	SHH60-ECHO	60	102	4	5	€ 16,66
	SHH64-ECHO	64	102	4	5	€ 17,42
	SHH68-ECHO	68	102	4	5	€ 17,99
	SHH70-ECHO	70	102	4	5	€ 18,18
	SHH76-ECHO	76	102	4	5	€ 19,69
	SHH83-ECHO	83	102	4	5	€ 22,34
	SHH89-ECHO	89	102	4	5	€ 24,75
	SHH95-ECHO	95	102	4	5	€ 26,93
	SHH102-ECHO	102	102	4	5	€ 29,58
	SHH80-ECHO	80	102	4	5	€ 22,22

Curva siliconica a 45° / 45 ° silicone elbow hose						
Disegno / Drawing	Codice / Part Numebr	I.D. Diametro interno (mm)	Lunghezza / Leg (mm)	Strati / Ply	Spessore parete / Wall(mm)	Listino € iva esclusa /Price List
	AE45-6,5-ECHO	6	120	3	4,5	€ 10,35
	AE45-8-ECHO	8	120	3	4,5	€ 10,43
	AE45-9.5-ECHO	9,5	120	3	4,5	€ 10,47
	AE45-11-ECHO	11	120	3	4,5	€ 10,48
	AE45-13-ECHO	13	120	3	4,5	€ 10,60
	AE45-16-ECHO	16	120	3	4,5	€ 10,96
	AE45-19-ECHO	19	120	3	4,5	€ 11,42
	AE45-22-ECHO	22	120	3	4,5	€ 11,87
	AE45-25-ECHO	25	120	3	4,5	€ 12,33
	AE45-28-ECHO	28	120	3	4,5	€ 12,78
	AE45-30-ECHO	30	120	3	4,5	€ 13,34
	AE45-32-ECHO	32	120	3	4,5	€ 13,40
	AE45-35-ECHO	35	120	3	4,5	€ 13,85
	AE45-38-ECHO	38	120	3	4,5	€ 14,31
	AE45-40-ECHO	40	120	3	4,5	€ 14,76
	AE45-45-ECHO	45	120	3	4,5	€ 15,36
	AE45-50-ECHO	50	120	4	5	€ 16,27
	AE45-54-ECHO	54	120	4	5	€ 16,74
	AE45-57-ECHO	57	120	4	5	€ 17,19
	AE45-60-ECHO	60	120	4	5	€ 17,65
	AE45-64-ECHO	64	120	4	5	€ 18,10
	AE45-68-ECHO	68	120	4	5	€ 18,23
	AE45-70-ECHO	70	120	4	5	€ 22,53
	AE45-76-ECHO	76	120	4	5	€ 28,73
	AE45-80-ECHO	80	120	4	5	€ 29,67



AE45-83-ECHO	83	120	4	5	€	30,38
AE45-89-ECHO	89	120	4	5	€	31,82
AE45-95-ECHO	95	120	4	5	€	33,81
AE45-102-ECHO	102	120	4	5	€	34,91
AE45-114-ECHO	114	120	4	5	€	36,23

Riduzione siliconica a 45° / 45° reducers silicone elbow hose

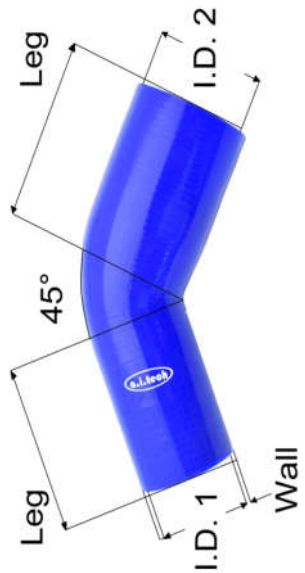
Disegno / Drawing	Codice / Part Numbr	I.D. Diametro interno (mm)	Lunghezza / Leg (mm)	Strati / Ply	Spessore parete / Wall(mm)	Listino € iva esclusa /Price List
	ARE45-19-13-ECHO	19-13	120	3	4,5	€ 11,36
	ARE45-19-16-ECHO	19-16	120	3	4,5	€ 11,82
	ARE45-19-25-ECHO	19-25	120	3	4,5	€ 15,14
	ARE45-19-22-ECHO	19-22	120	3	4,5	€ 14,11
	ARE45-32-25-ECHO	32-25	120	3	4,5	€ 17,42
	ARE45-38-25-ECHO	38-25	120	3	4,5	€ 18,63
	ARE45-38-32-ECHO	38-32	120	3	4,5	€ 19,69
	ARE45-38-51-ECHO	38-51	120	4	5	€ 24,03
	ARE45-38-45-ECHO	38-45	120	4	5	€ 23,85
	ARE45-40-60-ECHO	40-60	120	4	5	€ 25,66
	ARE45-45-51-ECHO	45-51	120	4	5	€ 26,87
	ARE45-51-57-ECHO	51-57	120	4	5	€ 29,61
	ARE45-51-60-ECHO	51-60	120	4	5	€ 33,33
	ARE45-51-64-ECHO	51-64	120	4	5	€ 34,83
	ARE45-51-70-ECHO	51-70	120	4	5	€ 39,38
	ARE45-51-76-ECHO	51-76	120	4	5	€ 40,60
	ARE45-57-64-ECHO	57-64	120	4	5	€ 35,60
	ARE45-57-70-ECHO	57-70	120	4	5	€ 39,15
	ARE45-57-76-ECHO	57-76	120	4	5	€ 39,46
	ARE45-60-70-ECHO	60-70	120	4	5	€ 39,87
	ARE45-60-89-ECHO	60-89	120	4	5	€ 42,40
	ARE45-64-70-ECHO	64-70	120	4	5	€ 41,60
	ARE45-64-76-ECHO	64-76	120	4	5	€ 42,40
	ARE45-64-80-ECHO	64-80	120	4	5	€ 42,50
	ARE45-64-83-ECHO	64-83	120	4	5	€ 42,75

ARE45-64-89-ECHO	64-89	120	4	5	€	43,35
ARE45-70-76-ECHO	70-76	120	4	5	€	43,45
ARE45-70-80-ECHO	70-80	120	4	5	€	43,62
ARE45-76-80-ECHO	76-80	120	4	5	€	46,63
ARE45-76-89-ECHO	76-89	120	4	5	€	48,95
ARE45-76-102-ECHO	76-102	120	4	5	€	60,58
ARE45-80-90-ECHO	80-90	120	4	5	€	60,62
ARE45-83-89-ECHO	83-89	120	4	5	€	59,88
ARE45-83-102-ECHO	83-102	120	4	5	€	60,01
ARE45-89-102-ECHO	89-102	120	4	5	€	60,96

Curva siliconica a 90° / 90 ° silicone elbow hose

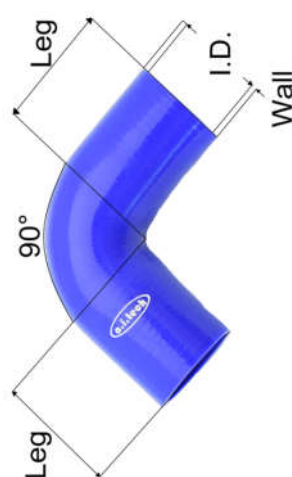
Disegno / Drawing	Codice / Part Numebr	I.D. Diametro interno (mm)	Lunghezza / Leg (mm)	Strati / Ply	Spessore parete / Wall(mm)	Listino € iva esclusa /Price List
	AE90-6,5-ECHO	6,5	120	3	4,5	€ 10,35
	AE90-8-ECHO	8	120	3	4,5	€ 10,43
	AE90-9,5-ECHO	9,5	120	3	4,5	€ 11,50
	AE90-11-ECHO	11	120	3	4,5	€ 10,48
	AE90-13-ECHO	13	120	3	4,5	€ 10,60
	AE90-16-ECHO	16	120	3	4,5	€ 10,96
	AE90-19-ECHO	19	120	3	4,5	€ 12,78
	AE90-22-ECHO	22	120	3	4,5	€ 11,87
	AE90-25-ECHO	25	120	3	4,5	€ 12,33
	AE90-28-ECHO	28	120	3	4,5	€ 12,78
	AE90-30-ECHO	30	120	3	4,5	€ 13,09
	AE90-32-ECHO	32	120	3	4,5	€ 13,40
	AE90-35-ECHO	35	120	3	4,5	€ 13,85
	AE90-38-ECHO	38	120	3	4,5	€ 14,31
	AE90-40-ECHO	40	120	3	4,5	€ 14,76
	AE90-45-ECHO	45	120	3	4,5	€ 15,36
	AE90-50-ECHO	50	120	4	5	€ 16,27
	AE90-55-ECHO	55	120	4	5	€ 16,74
	AE90-57-ECHO	57	120	4	5	€ 17,19
	AE90-60-ECHO	60	120	4	5	€ 17,65
AE90-64-ECHO	64	120	4	5	€ 22,18	

AE90-68-ECHO	68	120	4	5	€	22,34
AE90-70-ECHO	70	120	4	5	€	22,53
AE90-76-ECHO	76	120	4	5	€	28,73
AE90-80-ECHO	80	120	4	5	€	29,67
AE90-83-ECHO	83	120	4	5	€	30,38
AE90-89-ECHO	89	120	4	5	€	31,82
AE90-95-ECHO	95	120	4	5	€	33,33
AE90-102-ECHO	102	120	4	5	€	34,91
AE90-114-ECHO	114	120	4	5	€	43,47
AE90-127-ECHO	127	120	4	5	€	50,33

Riduzione siliconica a 90° / 90° reducers silicone elbow hose

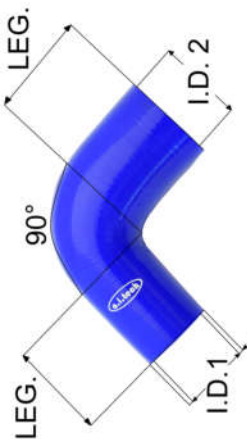
Disegno / Drawing	Codice / Part Numebr	I.D. Diametro interno (mm)	Lunghezza / Leg (mm)	Strati / Ply	Spessore parete / Wall(mm)	Listino € iva esclusa /Price List
	ARE90-19-13-ECHO	19-13	120	3	4,5	€ 11,36
	ARE90-19-16-ECHO	19-16	120	3	4,5	€ 11,82
	ARE90-19-25-ECHO	19-25	120	3	4,5	€ 15,14
	ARE90-19-22-ECHO	19-22	120	3	4,5	€ 14,11
	ARE90-32-25-ECHO	32-25	120	3	4,5	€ 17,42
	ARE90-38-25-ECHO	38-25	120	3	4,5	€ 18,63
	ARE90-38-32-ECHO	38-32	120	3	4,5	€ 19,69
	ARE90-38-51-ECHO	38-51	120	4	5	€ 21,13
	ARE90-38-45-ECHO	38-45	120	4	5	€ 22,73
	ARE90-45-51-ECHO	45-51	120	4	5	€ 23,26
	ARE90-51-54-ECHO	51-54	120	4	5	€ 23,55
	ARE90-51-57-ECHO	51-57	120	4	5	€ 23,92
	ARE90-51-60-ECHO	51-60	120	4	5	€ 27,26
	ARE90-51-64-ECHO	51-64	120	4	5	€ 28,02
	ARE90-51-67-ECHO	51-67	120	4	5	€ 30,07
	ARE90-51-70-ECHO	51-70	120	4	5	€ 30,29
	ARE90-51-76-ECHO	51-76	120	4	5	€ 33,33
	ARE90-55-60-ECHO	55-60	120	4	5	€ 27,47

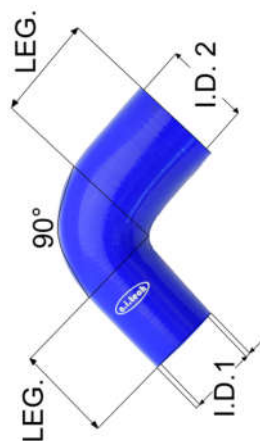

ARE90-57-60-ECHO	57-60	120	4	5	€	28,26
ARE90-57-64-ECHO	57-64	120	4	5	€	28,78
ARE90-57-70-ECHO	57-70	120	4	5	€	34,90
ARE90-57-76-ECHO	57-76	120	4	5	€	35,60
ARE90-60-70-ECHO	60-70	120	4	5	€	31,80
ARE90-64-70-ECHO	64-70	120	4	5	€	32,42
ARE90-64-76-ECHO	64-76	120	4	5	€	34,83
ARE90-64-95-ECHO	64-95	120	4	5	€	35,26
ARE90-70-76-ECHO	70-76	120	4	5	€	36,59
ARE90-70-80-ECHO	70-80	120	4	5	€	38,62
ARE90-76-80-ECHO	76-80	120	4	5	€	39,00
ARE90-76-60-ECHO	76-60	120	4	5	€	34,77
ARE90-76-83-ECHO	76-83	120	4	5	€	49,51
ARE90-76-89-ECHO	76-89	120	4	5	€	52,17
ARE90-76-102-ECHO	76-102	120	4	5	€	60,58
ARE90-89-102-ECHO	89-102	120	4	5	€	60,96
ARE90-102-127-ECHO	102-127	120	4	5	€	67,02



Curva siliconica a 120° / 120° silicone elbow hose

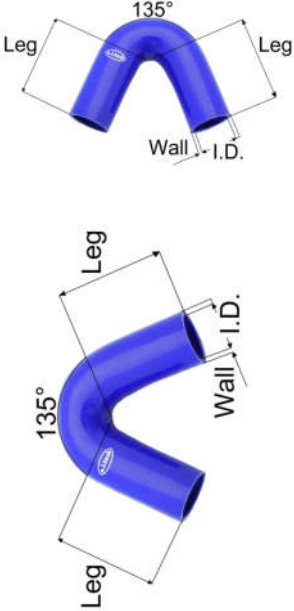

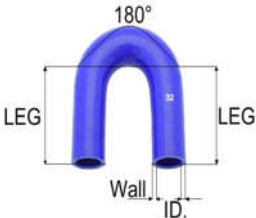
Disegno / Drawing	Codice / Part Numebr	I.D. Diametro interno (mm)	Lunghezza / Leg (mm)	Strati / Ply	Spessore parete / Wall(mm)	Listino € iva esclusa /Price List
	AE120-19-ECHO	19	120	3	4,5	€ 36,80
	AE120-25-ECHO	25	120	3	4,5	€ 39,10
	AE120-32-ECHO	32	120	3	4,5	€ 39,10
	AE120-38-ECHO	38	120	3	4,5	€ 24,83
	AE120-45-ECHO	45	120	3	4,5	€ 27,26
	AE120-50-ECHO	50	120	4	5	€ 29,24
	AE120-55-ECHO	55	120	4	5	€ 30,60
	AE120-57-ECHO	57	120	4	5	€ 31,65
	AE120-60-ECHO	60	120	4	5	€ 37,83
	AE120-64-ECHO	64	120	4	5	€ 40,26
	AE120-68-ECHO	68	120	4	5	€ 42,50
	AE120-70-ECHO	70	120	4	5	€ 43,68
	AE120-76-ECHO	76	120	4	5	€ 58,30
	AE120-80-ECHO	80	120	4	5	€ 58,69

	AE120-89-ECHO	89	120	4	5	€ 59,77
	AE120-95-ECHO	95	120	4	5	€ 63,15
	AE120-102-ECHO	102	120	4	5	€ 68,12
	AE120-114-ECHO	114	120	4	5	€ 72,85
Curva siliconica a 135° / 135° silicone elbow hose						
Disegno / Drawing	Codice / Part Numebr	I.D. Diametro interno (mm)	Lunghezza / Leg (mm)	Strati / Ply	Spessore parete / Wall(mm)	Listino € iva esclusa /Price List
	AE135-19-ECHO	19	120	3	4,5	€ 15,30
	AE135-25-ECHO	25	120	3	4,5	€ 17,88
	AE135-32-ECHO	32	120	3	4,5	€ 21,51
	AE135-38-ECHO	38	120	3	4,5	€ 24,83
	AE135-45-ECHO	45	120	3	4,5	€ 27,26
	AE135-50-ECHO	50	120	4	5	€ 29,24
	AE135-55-ECHO	55	120	4	5	€ 30,60
	AE135-57-ECHO	57	120	4	5	€ 31,65
	AE135-60-ECHO	60	120	4	5	€ 37,83
	AE135-64-ECHO	64	120	4	5	€ 40,26
	AE135-68-ECHO	68	120	4	5	€ 42,50
	AE135-70-ECHO	70	120	4	5	€ 43,68
	AE135-76-ECHO	76	120	4	5	€ 58,30
	AE135-80-ECHO	80	120	4	5	€ 58,69
	AE135-89-ECHO	89	120	4	5	€ 59,77
	AE135-95-ECHO	95	120	4	5	€ 63,15
	AE135-102-ECHO	102	120	4	5	€ 68,12
	AE135-114-ECHO	114	120	4	5	€ 72,85

Curva siliconica a 180° / 180° silicone elbow hose						
Disegno / Drawing	Codice / Part Numebr	I.D. Diametro interno (mm)	Lunghezza / Leg (mm)	Strati / Ply	Spessore parete / Wall(mm)	Listino € iva esclusa /Price List
	AE180-51-ECHO	51	120	4	5	€ 40,89
	AE180-64-ECHO	64	120	4	5	€ 49,25
	AE180-76-ECHO	76	120	4	5	€ 58,30
	AE180-89-ECHO	89	120	4	5	€ 61,29
	AE180-102-ECHO	102	120	4	5	€ 67,33
	AE180-127-ECHO	127	120	4	5	€ 69,61

Manicotto siliconico a T / T Silicon hose						
Disegno / Drawing	Codice / Part Numebr	I.D. Diametro interno (mm) I.D.2 = 25mm	Lunghezza / Leg (mm)	Strati / Ply	Spessore parete / Wall(mm)	Listino € iva esclusa /Price List
	ATP51-ECHO	51	102	4	5	€ 33,33
	ATP60-ECHO	60	102	4	5	€ 39,39
	ATP63-ECHO	63	102	4	5	€ 42,40
	ATP70-ECHO	70	102	4	5	€ 44,23
	ATP76-ECHO	76	102	4	5	€ 45,44
	Codice / Part Numebr	I.D. Diametro interno (mm) I.D.2 = 32mm	Lunghezza / Leg (mm)	Strati / Ply	Spessore parete / Wall(mm)	Listino € iva esclusa /Price List
	ATP51-ECHO	51	102	4	5	€ 34,99
	ATP60-ECHO	60	102	4	5	€ 41,36
	ATP63-ECHO	63	102	4	5	€ 44,52
	ATP70-ECHO	70	102	4	5	€ 46,44
	ATP76-ECHO	76	102	4	5	€ 47,71

Tubetto sfiato / Silicon Vacuum Tubing						
Disegno / Drawing	Codice / Part Numebr	Spessore parete , Diametro interno (mm)		Lunghezza (Mt)	Listino € iva esclusa /Price List	
	TUBE3-7-ECHO	3-7		5	€	18,88
	TUBE4-9-ECHO	4-9		5	€	21,41
	TUBE5-10-ECHO	5-10		5	€	24,57
	TUBE6-11-ECHO	6-11		5	€	27,80
	TUBE6-12-ECHO	6-12		5	€	35,72
	TUBE8-14-ECHO	8-14		5	€	43,65
	TUBE10-16-ECHO	10-16		5	€	51,58
	TUBE12-18-ECHO	12-18		5	€	59,52
	TUBE14-21-ECHO	14-21		5	€	80,90
	TUBE16-23-ECHO	16-23		5	€	90,79
	TUBE18-25-ECHO	18-25		5	€	102,64
Tubo corrugato in silicone/Kevlar/Nomex spirale in acciaio inox /						
Corrugate Pipe Silicone/Kevlar/Nomex stainlees steel spiral						
Disegno / Drawing	Codice / Part Numebr	I.D. Diametro interno (mm)	Lunghezza / Leg (mm)	Strati / Ply	Spessore parete / Wall(mm)	Listino € iva esclusa /Price List
	WH-NLH38	38	2000/4000	5	4	su richiesta
	WH-NLH54	54	2000/4000	5	4	su richiesta
	WH-NLH60	60	2000/4000	5	4	su richiesta
	WH-NLH70	70	2000/4000	5	4	su richiesta
	Tubo corrugato con spirale in acciaio inox passo 20mm, estremità lisce per migliorare la tenuta della fascetta. Ideale per liquidi e vapori alte pressioni (7bar) e per alte temperature (270°)					

Cuffie universali per i giunti omocinetici			
Disegno / Drawing	Codice / Part Numebr	Descrizione / Description	Listino € iva esclusa /Price List
 	AIT-FLEXSIL.R	Coppia cuffie siliconiche universali rosse	€ 19,80
	AIT-FLEXSIL.B	Coppia cuffie siliconiche universali rosse	€ 19,80
	AIT-FLEXSIL.BLK	Coppia cuffie siliconiche universali rosse	€ 19,80
<p>Sono arrivate le tanto richieste cuffie universali per i giunti omocinetici , rinforzate in silicone. Mai più rotture. Robuste , elastiche e durevoli. Disponibili in 3 colori diversi , sono dotate di 2 fascette in acciaio Inox per facilitare l'installazione</p>			

Materiale : Silicone ad alta resistenza e flessibilità.

Spessore parete : +- 2.5mm

-AIT-FLEXSIL-R
 -AIT-FLEXSIL-B
 -AIT-FLEXSIL-BLK

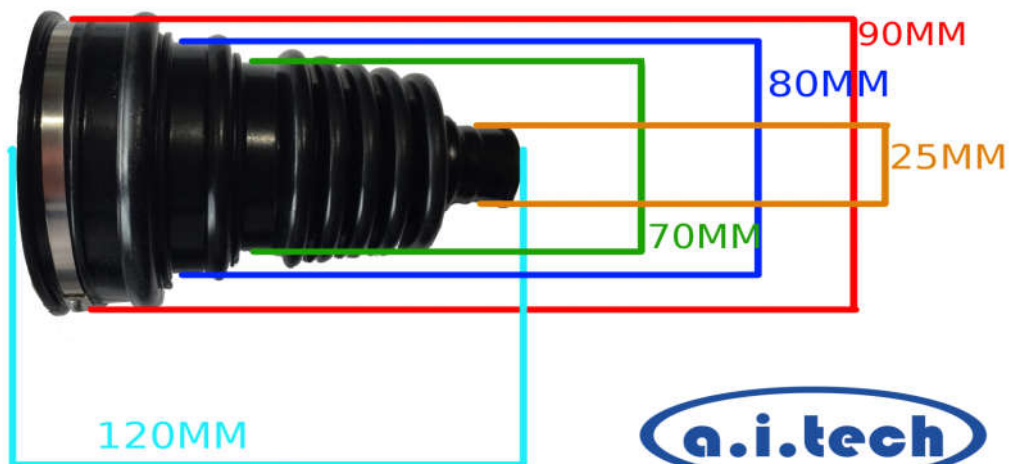

CONNESSIONI AUTO-SIGILLANTI / SELF-SEALING CONNECTIONS

Kit fornito completo di :

- 1 - Fustella per fare il foro
- 2 - Inserto auto-sigillante
- 3 - Rondella auto-sigillante
- 4 - Raccordo di uscita completodi dado
- 5 - O'Ring (solo su tubi rigidi).

Disegno / Drawing	Codice / Part Numebr	Descrizione / Description	Materiale /Material	Listino € iva esclusa /Price List
	AIT-SST-05	5mm Liscio	Acciaio Inox	€ 48,21
	AIT-SST-08	Connessione auto-sigillante 8mm	Alluminio	€ 48,21
	AIT-SST-10	Connessione auto-sigillante 10mm	Alluminio	€ 48,21
	AIT-SST-13	Connessione auto-sigillante 13mm	Alluminio	€ 48,21
	AIT-SST-16	Connessione auto-sigillante 16mm	Alluminio	€ 48,21
	AIT-SST-19	Connessione auto-sigillante 19mm	Alluminio	€ 48,21
	AIT-SST-25	Connessione auto-sigillante 25mm	Alluminio	€ 52,94
	AIT-SST-M5	M5 interno filettato	Acciaio Inox	€ 52,94
	AIT-SST-M10	Connessione auto-sigillante con filetto M10x1,0	Alluminio	€ 52,94
	AIT-SST-M12	Connessione auto-sigillante con filetto M12x1,5	Alluminio	€ 52,94
	AIT-SST-M14	Connessione auto-sigillante con filetto M14x1,5	Alluminio	€ 52,94
	AIT-SST-1/8	Connessione auto-sigillante con filetto 1/8NPT	Alluminio	€ 52,94
	AIT-SST-1/4	Connessione auto-sigillante con filetto 1/4NPT	Alluminio	€ 52,94
	AIT-SST-3/8	Connessione auto-sigillante con filetto 3/8BSP	Alluminio	€ 52,94



Istruzioni di montaggio Raccordi Auto-Sigillanti su Tubo siliconico

CREA DA SOLO IL BUCO IN MATERIALI MORBIDI COME GOMMA, SILICONE, ECC. :

1



1. Posizionare la fustella all'interno del tubo con la parte tagliente rivolta verso l'alto.
Posizionare un pezzo di legno sotto la fustella in modo da avere una battuta solida

2



2. Mettere il tubo su una superficie piana ,
per tagliare il foro colpire il manicotto in corrispondenza della fustella
con un martello di gomma.

3



3. Spingere il raccordo filettato attraverso il foro appena creato,
posizionare la rondella di tenuta con il labbro verso il materiale morbido
(utilizzare o-ring solo se materiale rigido)
ed avvitare l' uscita al filetto maschio.



Fascette metalliche a tensione costante per turbine tipo SAE by Murray.

Codice / Part Numebr	Descrizione / Description	mm	DECIMALE	POLLICI		Confezione minima acquistabile / Minimum Pack	Listino € CAD iva escl. /Price List each
TSS14S30EP00C	Fascetta Murray	da 28 a 38mm	1,12 - 1,50	1-1/8	1-1/2	400	€ 4,79
TSS16S30EP00C	Fascetta Murray	da 30 a 41mm	1,20 - 1,63	1-1/5	1-5/8	400	€ 4,69
TSS18S30EP00C	Fascetta Murray	da 33 a 44mm	1,28 - 1,75	1-1/4	1-3/4	su richiesta	su richiesta
TSS20S30EP00C	Fascetta Murray	da 35 a 48mm	1,37 - 1,88	1-3/8	1-7/8	400	€ 5,02
TSS24S30EP00C	Fascetta Murray	da 40 a 54mm	1,56 - 2,13	1-9/16	2-1/8	300	€ 5,04
TSS28S30EP00C	Fascetta Murray	da 41 a 60mm	1,63 - 2,38	1-5/8	2-3/8	300	€ 5,06
TSS32S30EP00C	Fascetta Murray	da 46 a 67mm	1,80 - 2,63	1-13/16	2-5/8	200	€ 5,06
TSS36S30EP00C	Fascetta Murray	da 50 a 73mm	1,97 - 2,88	1-31/32	2-7/8	200	€ 5,48
TSS40S30EP00C	Fascetta Murray	da 57 a 79mm	2,25 - 3,13	2-1/4	3-1/8	200	€ 5,58
TSS44S30EP00C	Fascetta Murray	da 64 a 86mm	2,50 - 3,38	2-1/2	3-3/8	200	€ 6,06
TSS48S30EP00C	Fascetta Murray	da 70 a 92mm	2,75 - 3,63	2-3/4	3-5/8	200	€ 5,81
TSS52S30EP00C	Fascetta Murray	da 76 a 98mm	3,00 - 3,88	3	3-7/8	200	€ 6,41
TSS56S30EP00C	Fascetta Murray	da 83 a 105mm	3,25 - 4,13	3-1/4	4-1/8	200	€ 7,00
TSS60S30EP00C	Fascetta Murray	da 89 a 111mm	3,50 - 4,38	3-1/2	4-3/8	200	€ 7,33
TSS64S30EP00C	Fascetta Murray	da 95 a 118mm	3,75 - 4,63	3-3/4	4-5/8	200	€ 7,06
TSS68S30EP00C	Fascetta Murray	da 102 a 124mm	4,00 - 4,88	4	4-7/8	su richiesta	su richiesta
TSS72S30EP00C	Fascetta Murray	da 108 a 130mm	4,25 - 5,12	4-1/4	5-1/8	200	€ 7,79
TSS76S30EP00C	Fascetta Murray	da 114 a 137mm	4,50 - 5,38	4-1/2	5-3/8	su richiesta	su richiesta
TSS80S30EP00C	Fascetta Murray	da 121 a 143mm	4,75 - 5,63	4-3/4	5-5/8	100	€ 8,73
TSS84S30EP00C	Fascetta Murray	da 127 a 149mm	5,00 - 5,88	5	5-7/8	su richiesta	su richiesta
TSS88S30EP00C	Fascetta Murray	da 133 a 156mm	5,25 - 6,13	5-1/4	6-1/8	su richiesta	su richiesta
Codice / Part Numebr	Descrizione / Description	mm	DECIMALE	POLLICI		Confezione minima acquistabile / Minimum Pack	Listino € CAD iva escl. /Price List each
TSS92S30EP00C	Fascetta Murray	da 140 a 162mm	5,50 - 6,38	5-1/2	6-3/8	su richiesta	su richiesta
TSS96S30EP00C	Fascetta Murray	da 146 a 168mm	5,75 - 6,63	5-3/4	6-5/8	100	€ 8,73
TSS104S30EP00C	Fascetta Murray	da 159 a 181mm	6,25 - 7,13	6-1/4	7-1/8	100	€ 8,95
TSS112S30EP00C	Fascetta Murray	da 172 a 194mm	6,75 - 7,63	6-3/4	7-5/8	su richiesta	su richiesta

TSS116S30EP00C	Fascetta Murray	da 178 a 200mm	7,00 - 7,88	7	7-7/8	su richiesta	su richiesta
TSS120S30EP00C	Fascetta Murray	da 184 a 206mm	7,25 - 8,13	7-1/4	8-1/8	100	€ 9,52



Le fascette metalliche a tensione costante sono progettate per compensare gli effetti provocati da elevati cicli termici, la compressione e l'estensione dei manicotti siliconici. Le doppie molle, quelle esterne alla fascetta e quelle interne lavorano insieme e impediscono ogni movimento del tubo e della fascetta stessa. L'elettrolucidatura, oltre a donare una ottima finitura, migliora la resistenza del metallo, aumentando le performance della fascetta e impedendo la corrosione. Questa speciale fascetta è usata per moltissime applicazioni: Automotive, Agricoltura, industria Aeronautica e industria Militare. È perfetta per assicurare i manicotti siliconici a Turbine, a serbatoi carburante e a giri aria / giri acqua. Il disegno interno, denominato "Dual Bead Shield" permette una tenuta maggiore di oltre il 30% rispetto alle tradizionali fascette. I bordi smussati inoltre, evitano danni ai materiali morbidi come il silicone.

Informazioni aggiuntive su i materiali di costruzione:

Materiale Molla esterna: Acciaio Inox speciale, con ottimi proprietà elastiche.

Materiale alloggiamento: Acciaio Inox serie 300

Materiale Vite: Acciaio Inox serie 300

Massima coppia di serraggio applicabile: 8,5 nm

Coppia di serraggio consigliata: 5,6 nm

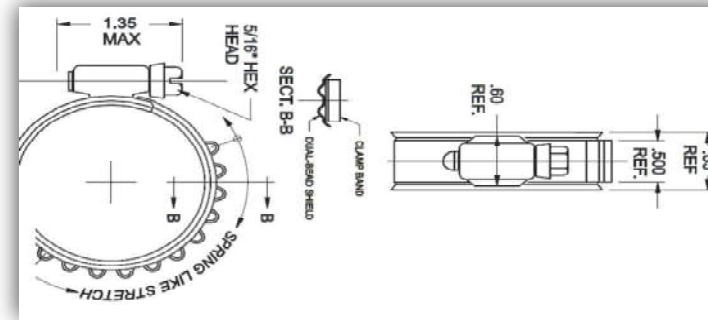

Nel grafico sottostante si può vedere come una fascetta Murray TSS mantenga maggior stabilità e sicurezza dopo un ciclo di stress ad alta temperatura ed a alta pressione

